



EXHIBITOR KIT

**92ND SHOCK & VIBRATION SYMPOSIUM
SEPTEMBER 18 - 22, 2022
DENVER**

WWW.SAVECENTER.ORG

WHY EXHIBIT AT OUR SYMPOSIUM?

The continuous service record and the community rapport of the Shock and Vibration Symposium speaks for itself. With 89 Symposia under the community's belt, the 92nd Symposium promises to deliver what the organization has come to pride itself on; a quality technical conference. With the conference comes over 200 technical papers, tutorials, meetings, discussion groups, and other fora presented from experts in their field.

These presentations are geared toward an audience of approximately 350-500 representatives of the US Government and the commercial sector of the shock and vibration community. These attendees range in assignment from project engineers and program developers to project managers and product developers. We also have representatives from academia and have attendance from over a dozen different countries.

We have attracted the largest names in measurement, testing, and equipment in our exhibit hall. Below is a list of many of the exhibitors who have joined us in the last few years.

Advanced Antivibration Corp.	Electric Boat Corporation	National Technical Systems
Advanced Test Equip. Rentals	Endevco	NAVSEA Warfare Centers
Aberdeen Test Center	ETS Solution NA	NEi Software
ABS Consulting	HBM Test & Measurement	Newport News Industrial
Aero Nav Laboratories	Hi-Techniques	Northrop Grumman
Air Force Rsch, Laboratory	HI-TEST Laboratories	Orbital ATK
Allied Defense Industries	Huntington Ingalls Industries	OROS
Altair Engineering	IDC	Pacific Instruments
Applied Physical Sciences	IES Global Inc.	PCB Piezotronics
Autodesk	IOTech	Precision Filters
Bodie Technology	IMC Corporation	Society of Exp. Mechanics
Boeing	IMV Corporation	Shock Tech
Bruel and Kjaer	Instrumented Sensor Technology	SIMULIA
Correlated Solutions	ITT Enidine	Spectral Dynamics
Crystal Instruments	Kellett Enterprises	SPEKTRA
Data Physics Corp.	Kistler Instruments	Taylor Devices
Dayton T. Brown	Kulite Semiconductor Products	TEAM Corporation
DEWESoft	Lansmont Corporation	Thorntom Tomasetti
Dept. of Homeland Security	m+p International	US Army ERDC
Diversified Technical Sys	Moog CSA Engineering	Vibration Research Corp.
Defense Threat Reduction Agency	MREL Group	Vibro/Dynamics
Dytran Instruments	Muller BBM	Xcitex Inc
E-Labs Inc.	National Instruments	Weiss Technik Testing Services



ATTENDANCE FROM INDUSTRY LEADERS

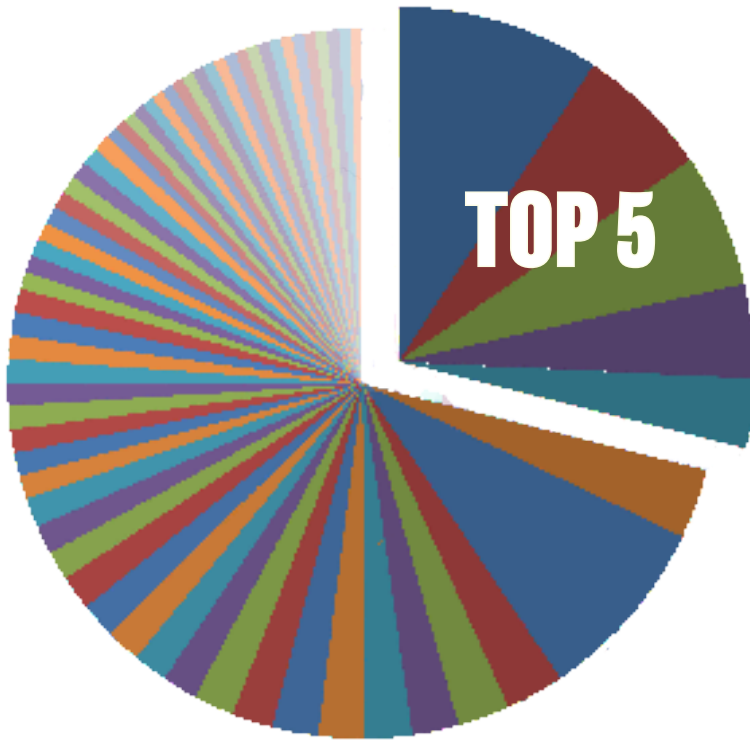

- NAVAL UNDERSEA WARFARE CENTERS
- US ARMY CORPS OF ENGINEERS
- SANDIA NATIONAL LABORATORIES
- HUNTINGTON INGALLS INDUSTRIES
- LOCKHEED MARTIN CORPORATION

...ROUNDING OUT THE TOP 20

- CANADIAN NAVY & CONTRACTORS
- TESTING LABORATORIES
- ACADEMIC UNIVERSITIES
- NORTHROP GRUMMAN
- AIR FORCE RESEARCH LABORATORY
- GENERAL DYNAMICS
- US ARMY ARDEC
- INDEPENDENT CONSULTANTS
- NAVAL NUCLEAR LABORATORY
- PCB PIEZOTRONICS
- BOEING
- NVT GROUP
- SUPSHIP
- THORNTON TOMASETTI

100%

RETURN RATE FOR FIRST TIME EXHIBITORS



8 OUT OF 10 ATTENDEES HAVE PURCHASING INFLUENCE

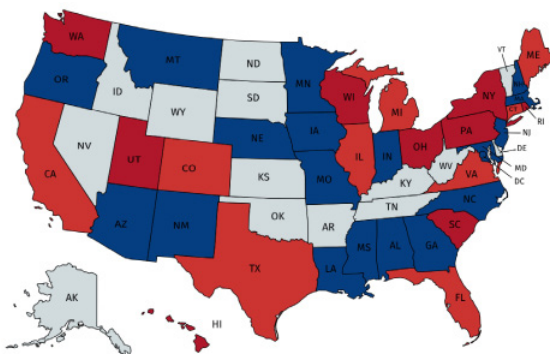

ATTENDEES FROM EVERY REGION OF THE US

NEW

20-30% NEW ATTENDEE POOL EACH YEAR

EXHIBIT PRICING

10' x 10' EXHIBIT PACKAGE

\$2,500

INCLUDES: 10'X10' EXHIBIT SPACE, STANDARD ELECTRICITY, TWO CHAIRS, TABLE, AND ONE BADGE TO ATTEND TECHNICAL SESSIONS

10' x 20' EXHIBIT PACKAGE

\$4,500

INCLUDES: 10'X 20' EXHIBIT SPACE (SUBJECT TO AVAILABILITY), ELECTRICITY, FOUR CHAIRS, TWO TABLES, AND ONE BADGE TO ATTEND TECHNICAL SESSIONS

CORPORATE SUPPORTER PACKAGES

BRONZE CORPORATE SUPPORTER

\$4,000

INCLUDES: BASIC EXHIBIT PACKAGE + TWO (2) COMPLIMENTARY BADGES TO ATTEND TECHNICAL SESSIONS, ONE (1) TUTORIAL PER COMPLIMENTARY REGISTRANT, AND A 2023 CALENDAR AD

SILVER CORPORATE SUPPORTER

\$6,000

INCLUDES: BASIC EXHIBIT PACKAGE + FOUR (4) COMPLIMENTARY BADGES TO ATTEND TECHNICAL SESSIONS, ONE (1) TUTORIAL PER COMPLIMENTARY REGISTRANT, AND A 2023 CALENDAR AD

GOLD CORPORATE SUPPORTER

\$10,000

INCLUDES: 10' X 20' EXHIBIT SPACE (DUAL BOOTH), SIX (6) COMPLIMENTARY BADGES TO ATTEND TECHNICAL SESSIONS, TWO (2) TUTORIALS PER COMPLIMENTARY REGISTRANT, A 2023 CALENDAR AD, WELCOME PACKAGE SPONSORSHIP (LOGO ON EVENT PROGRAMS AND RECOGNITION IN THE WELCOME PACKET/BAG)

SPONSORSHIP OPPORTUNITIES

- **ICE CREAM SOCIAL SPONSORSHIP** **SOLD!** **\$750**
INCLUDES: SIGNAGE FOR EVENT, RECOGNITION DURING EVENT, AND ICE CREAM CART AND OR NEAR YOUR EXHIBIT SPACE FOR HANDING OUT DURING SOCIAL.
- **LANYARD SPONSORSHIP (1)** **SOLD!** **\$500**
GET YOUR COMPANY NAME AND LOGO VISIBLE AROUND THE NECKS OF ALL SYMPOSIUM ATTENDEES. LANYARDS ARE TO BE PROVIDED BY SPONSOR AND WILL BE MADE AVAILABLE TO ALL ATTENDEES AT EVENT CHECK-IN.
- **CONFERENCE WI-FI SPONSORSHIP (1)** **SOLD!** **\$500**
ACCESSIBILITY IS KEY IN THIS DIGITAL AGE! ATTENDEES SEE YOUR COMPANY'S LOGO ON THE SPLASH SCREEN* OR SET THE CONFERENCE WI-FI PASSWORD* TO YOUR COMPANY NAME! *EXACT OPTION DEPENDS ON CAPABILITIES OF VENUE
- **CELL PHONE CHARGING STATION (2)** **\$500**
A CELL PHONE CHARGING STATION SET UP NEAR YOUR BOOTH ATTENDEES WHO NEED AN EXTRA BOOST! SIGNAGE PLACED ON THE CELL PHONE CHARGING STATION WITH YOUR COMPANY'S LOGO.
- **NOTEPADS & PENS (1)** **SOLD!** **\$500**
NOTEPADS AND PENS WITH YOUR COMPANY'S LOGO* WILL BE PROVIDED IN THE REGISTRATION PACKET OR IN MEETING ROOMS FOR ATTENDEES. *SAVE LOGO AND/OR EVENT NAME MAY ALSO BE USED

ALL SPONSORSHIPS ARE SECURED ON A FIRST-COME, FIRST-SERVED BASIS.

ALL SPONSORSHIPS ARE SUBJECT TO AVAILABILITY OF RESOURCES, CAPABILITY OF VENUE, AND OTHER FACTORS THAT CANNOT BE CONTROLLED BY SAVE STAFF.

VENDOR SESSION

Exhibitors have been a growing part of why the S&V Symposium is successful. To provide exhibitors with more opportunities to reach attendees, the Shock and Vibration Exchange is offering a vendor session.

HOW IT WORKS:

- Each vendor who registers will be scheduled to provide a 20-minute presentation about a new technology, case study, or otherwise interesting topic of **technical interest** to our attendees.
- Presenters may use a prepared video presentation, perform a demonstration, or perform an oral presentation.
- Any questions after the allotted time slot of the presentation should be addressed with a business card or invitation to the attendee to visit the exhibit booth after the session.

HOW TO PARTICIPATE:

COMPLETE AND RETURN THE FOLLOWING FIELDS BY JUNE 1, 2022:

COMPANY NAME: _____

PRESENTER NAME: _____

PRESENTATION TITLE: _____

ABSTRACT: PLEASE SUBMIT A BRIEF ABSTRACT TO ASHLEY SHUMAKER
NO LATER THAN JULY 1, 2022.

- Applications submitted after June 1 will be subject to availability.
- Presenters must submit their presentation in advance using the online upload link.
- Exhibitors do not have to be registered with a session badge to attend this session. All symposium attendees and exhibitors will be able to attend the vendor sessions.

FOR QUESTIONS, CONTACT OUR OFFICE AT 434.581.3041 OR BY EMAIL:

DREW PERKINS - DREW.PERKINS@SAVECENTER.ORG

ASHLEY SHUMAKER - ASHLEY.SHUMAKER@SAVECENTER.ORG

PASSPORT PROGRAM

The Passport Program is popular amongst industry conferences. The Passport Program aims to increase attendance in the exhibit hall and increase serious leads for our exhibitors.

HOW IT WORKS:

- Each Symposium attendee will be given a “passport” with a listing of participating companies.
- Participating vendors will be given a customized stamp or sticker.
- Vendors will affix stamp to the passport of an attendee that visits and/or engages with the vendor.
- Attendees who collect the required number of stamps of participating vendors will turn in their completed entry form and be eligible for the drawings.
- SAVE provides three top prizes. However, we also appreciate donations by participating vendors to attract more participants.

HOW TO PARTICIPATE:

- Cost per vendor is \$150.
- **Deadline to register is July 1, 2022.**
- Complete and return the following fields:

COMPANY NAME: _____

POINT OF CONTACT: _____

WILL YOUR COMPANY DONATE ANY PRIZES TO THE DRAWING? YES NO

IF YES, WHAT NATURE OF PRIZE? _____
(GIFT CARD, ELECTRONIC DEVICE, VENDOR HARDWARE/SOFTWARE)

PAYMENT METHOD: CREDIT CARD CHECK

USE CREDIT CARD INFORMATION FROM PAGE 11 HEREIN.

CREDIT CARD NUMBER: _____

EXPIRATION DATE: ____ / ____ CID: _____

CARDHOLDER EMAIL: _____



BTH #	COMPANY NAME	BTH #	COMPANY NAME
F1	NTS	101	HUTCHINSON
F2	ALTAIR	102	MIDE/ENDAQ
F3	SOCIETY OF EXPERIMENTAL MECHANICS	103	CORRELATED SOLUTIONS
F4	MECALC	104	PCB PIEZOTRONICS
F5	ADVANCED TEST EQUIPMENT RENTALS	105	E-LABS
F6	HI-TEST LABORATORIES	106	TAYLOR DEVICES
F7	PHOTRON		
		201	ENIDINE
G1	GIBBS & COX	202	DYTRAN
G2	CRYSTAL INSTRUMENTS	203	DAYTON T BROWN
G3	VIBRATION RESEARCH CORP	204	M+P
G4	HUNTINGTON INGALLS	205	INSTRUMENTED SENSOR TECHNOLOGY
G5	VIBRO DYNAMICS	206	DEWESOFT
G6	EXPERIOR LABORATORIES		
G7	BOEING	301	BODIE TECH
G8	THORNTON TOMASETTI	302	PRECISION FILTERS
G9	LANSMONT CORPORATION	303	HI-TECHNIQUES
G10	XCITEX	304	SPEKTRA
G11	SIEMENS	305	SPECTRAL DYNAMICS
G12	IX CAMERAS	306	SPECTRAL DYNAMICS

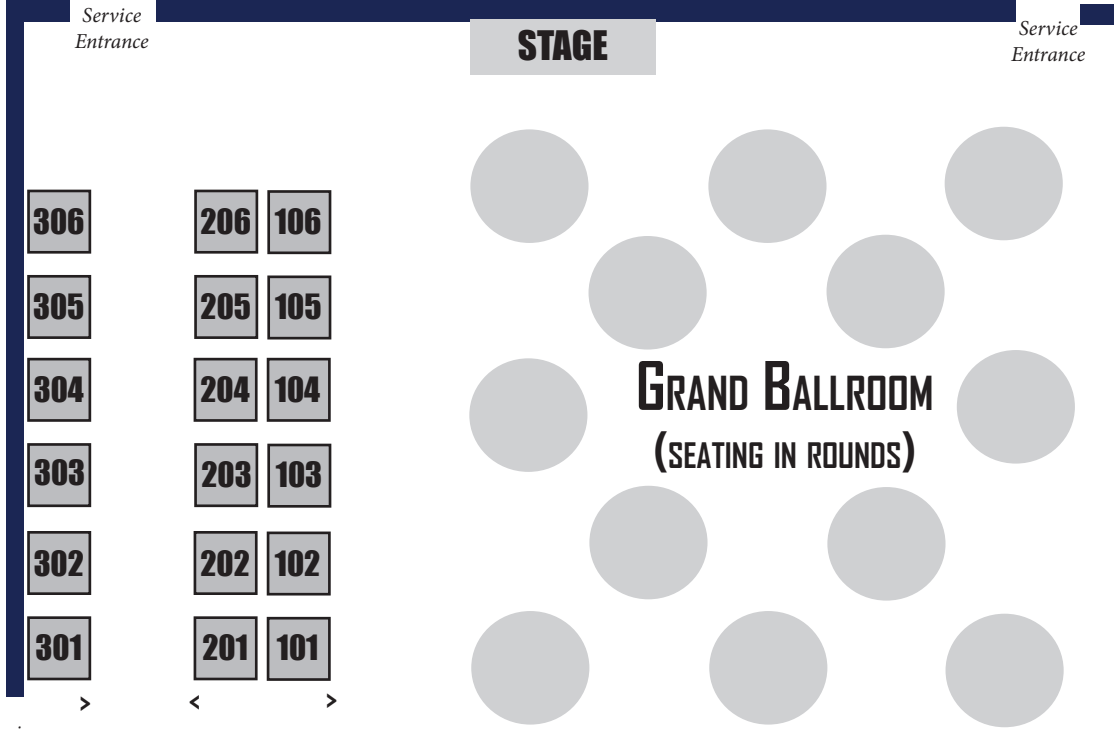

 AVAILABLE BOOTHS

 RESERVED BOOTHS

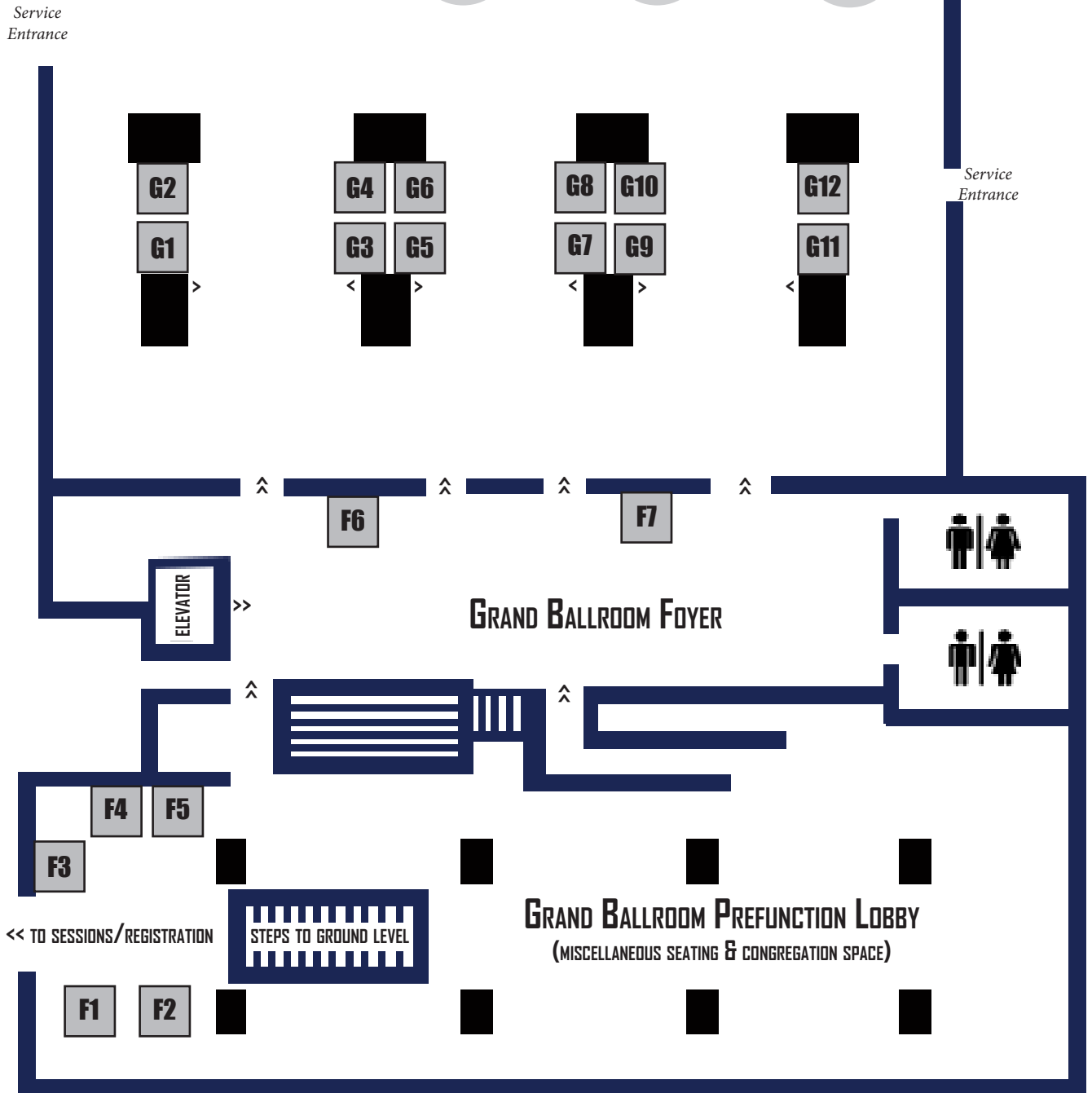

EXHIBIT PROVISIONS

BOOTH SPACE ASSIGNMENT

Booth assignments will be made based on a first-come, first-served basis with preference given to exhibitors participating as corporate supporters.

EXHIBIT SUPPORT PERSONNEL

Each booth space is provided with two chairs to accommodate support personnel. So long as additional personnel do not interfere with other exhibitors or traffic of the exhibit hall, they will be allowed. Staff must be registered. No fees will be assessed unless attending technical sessions. Exhibit staff are allowed all meals and entry into all socials.

LIABILITY STATEMENT

HI-TEST Laboratories, Inc. assumes no liability for loss, damage, or theft of goods rented or leased by the exhibitor. The exhibitor shall indemnify HI-TEST against and hold harmless for any complaints, suits or liabilities resulting from negligence in connection with the exhibitor's use of the display space. HI-TEST is not responsible for damage sustained in storage, setup, or shipping of exhibit property.

EXHIBITOR FLOORPLAN

SAVE/HI-TEST staff reserves the right to amend the floorplan, if, in its judgement, it is in the best interest of the Exhibition and overall needs of the conference. The Hotel also reserves the right to change the floorplan based on local codes, ordinances, or construction requiring a change in the flow of the hotel.

REGISTRATION AND PAYMENT

Reservations can be made by completing the exhibitor form. All forms for special offerings or items requiring separate registration must also be completed.

Payment is expected within 30 days of booth reservation, or by August 15th. SAVE/HI-TEST accepts credit cards and corporate checks. Checks should be made payable to HI-TEST Laboratories and mailed to PO Box 165, Arvon, VA 23004.

CANCELLATION AND REFUND

All cancellations must be received in writing and submitted to Ashley Shumaker or Drew Perkins.

The following schedule will be used in determining penalties (dates listed are when formal written notice is received):

- Prior to June 1: 0% penalty. 100% refunded.
- June 1- July 15: 50% penalty. 50% refunded.
- July 16 - Aug 15: 75% penalty. 25% refunded.
- After August 15: 100% penalty. 0% refunded.

SHIPMENT OF EXHIBIT MATERIALS

Each exhibiting company is responsible for payment of inbound and outbound shipment fees as dictated by the venue and provided herein. For questions regarding handling fees and storage fees, please contact the venue directly. In the event that all storage fees are charged to the SAVE Master Account, all exhibitors will be required to reimburse SAVE using published hotel handling rates.

EXHIBITOR REGISTRATION FORM

I. COMPANY/ORGANIZATION INFORMATION

COMPANY NAME: _____

ADDRESS: _____

CITY: _____ STATE: _____ ZIP: _____ COUNTRY: _____

BOOTH CONTACT: _____ EMAIL: _____

II. REGISTRATION

EXHIBIT PACKAGES	SPONSORSHIP ADD-ONS	OTHER PROMOTIONAL OPPORTUNITIES
<input type="checkbox"/> \$2,500 10' x 10' EXHIBITOR PACKAGE <input type="checkbox"/> \$4,500 10' x 20' EXHIBITOR PACKAGE + <p style="text-align: center;">OR</p> <input type="checkbox"/> \$4,000 BRONZE PACKAGE <input type="checkbox"/> \$6,000 SILVER PACKAGE <input type="checkbox"/> \$10,000 GOLD PACKAGE	<input type="checkbox"/> \$750 ICE CREAM SOCIAL <input type="checkbox"/> \$500 LANYARD SPONSORSHIP + <input type="checkbox"/> \$500 WI-FI SPONSORSHIP <input type="checkbox"/> \$500 CHARGING STATION SPONSOR <input type="checkbox"/> \$500 NOTEPADS & PENS SPONSOR	<input type="checkbox"/> \$150 PASSPORT PROGRAM* <input type="checkbox"/> \$0 VENDOR SESSION* <p style="text-align: center;">*COMPLETE FORM HEREIN FOR EACH</p>

TOTAL FOR PACKAGE & ADD-ONS SELECTED IN SECTION II: \$ _____

III. BOOTH SELECTION & PERSONNEL (SEE PAGE 9 FOR EXHIBIT FLOORPLAN)

BOOTH PREFERENCE: (1) _____ (2) _____ (OTHER REQUESTS?) _____

BOOTH PERSONNEL: All booth personnel must complete the online registration form (print copy also available).

IV. PAYMENT INFORMATION

PAYMENT AMOUNT SHOULD EQUAL TOTAL FROM SECTION II (REGISTRATION OPTIONS). IF YOU WOULD LIKE TO BE INVOICED, PLEASE CHECK THE APPROPRIATE BOX BELOW. PLEASE NOTE THAT PAYMENT MUST BE RECEIVED WITHIN 30 DAYS OF REGISTRATION. ACCEPTABLE METHODS OF PAYMENT ARE CHECK OR ANY MAJOR CREDIT CARD. WE DO NOT ACCEPT BANK TRANSFERS.

CHECK: *MADE PAYBLE TO HI-TEST LABORATORIES (NUMBER) _____ (DATE) _____

CREDIT CARD:

CC NUMBER _____ NAME ON CARD: _____

EXP DATE: _____ BILLING ZIP CODE: _____ SECURITY CODE: _____

EMAIL ADDRESS FOR RECEIPT: _____

SUBMIT COMPLETED FORM TO ASHLEY.SHUMAKER@SAVECENTER.ORG OR FAX TO 434.581.3037.



EXHIBIT SCHEDULE

PLEASE NOTE THAT ALL TIMES BELOW ARE SUBJECT TO CHANGE BASED ON TECHNICAL CONTENT AND MEETING ROOM AVAILABILITY.

MONDAY, SEPTEMBER 19, 2022

Exhibit Setup*	12:00pm - 6:00pm
<i>*Booths MUST be operational by 6:00pm on 9/19/2022.</i>	
Reception (in Exhibit Hall)	6:30pm - 8:30pm

TUESDAY, SEPTEMBER 20, 2022

Exhibit Area Open	7:00am - 5:00pm
Breakfast (in Exhibit Hall)	7:00am - 8:30am
Luncheon (in Exhibit Hall)	11:00am - 1:00pm
Ice Cream Social	3:00pm - 3:40pm

WEDNESDAY, SEPTEMBER 21, 2022

Exhibit Area Open	9:00am - 4:00pm
Breakfast (in Exhibit Hall)	7:00am - 8:30am
Morning Break (in Exhibit Hall)	9:45am - 10:15am
Exhibitors' Luncheon	12:00am - 1:30pm
Break w/ Passport Program Raffle	3:30pm - 4:00pm
Exhibitor Dismantle	4:00pm - 6:00pm

FURNITURE, A/V RENTALS, & FEES

ALL BOOTHS ARE PROVIDED WITH TWO CHAIRS, A DRAPED TABLE, AND ACCESS TO ELECTRICITY.

NO OTHER PIPE AND DRAPE, CARPET, FURNITURE, OR A/V RENTALS ARE REQUIRED OR INCLUDED.

HOWEVER, SHOULD YOUR COMPANY WISH TO SECURE ADDITIONAL RESOURCES FOR YOUR BOOTH, PLEASE CONTACT THE A/V PROVIDER AT THE SHERATON DOWNTOWN DENVER DIRECTLY.



SHIPPING INSTRUCTIONS & FEES

TBD



IMPORTANT DATES & CHECKLIST

- | | |
|--|--|
| <input type="checkbox"/> ASAP: | REGISTER AS AN EXHIBITOR |
| <input type="checkbox"/> BEFORE MAY 30: | SUBMIT ABSTRACTS FOR TECHNICAL PRESENTATIONS |
| <input type="checkbox"/> BEFORE JUNE 1: | SUBMIT FORMS FOR VENDOR SESSION PARTICIPATION |
| <input type="checkbox"/> BEFORE JULY 1: | REGISTER FOR PASSPORT PROGRAM |
| <input type="checkbox"/> BEFORE AUG 15: | REGISTER FOR SYMPOSIUM EARLY BIRD RATE |
| <input type="checkbox"/> ON/BY SEPT 18: | SHIPMENTS ARRIVE AT HOTEL FOR BOOTH |

SHOCK & VIBRATION EXCHANGE

 **PO Box 165**
ARVONIA, VA 23004

 **434.581.3041**
434.581.3037



PROGRAM MANAGER:
MANAGER OF OPERATIONS:

DREW.PERKINS@SAVECENTER.ORG
ASHLEY.SHUMAKER@SAVECENTER.ORG